

# H 80 / H 100 / HG 100 / HGH 100

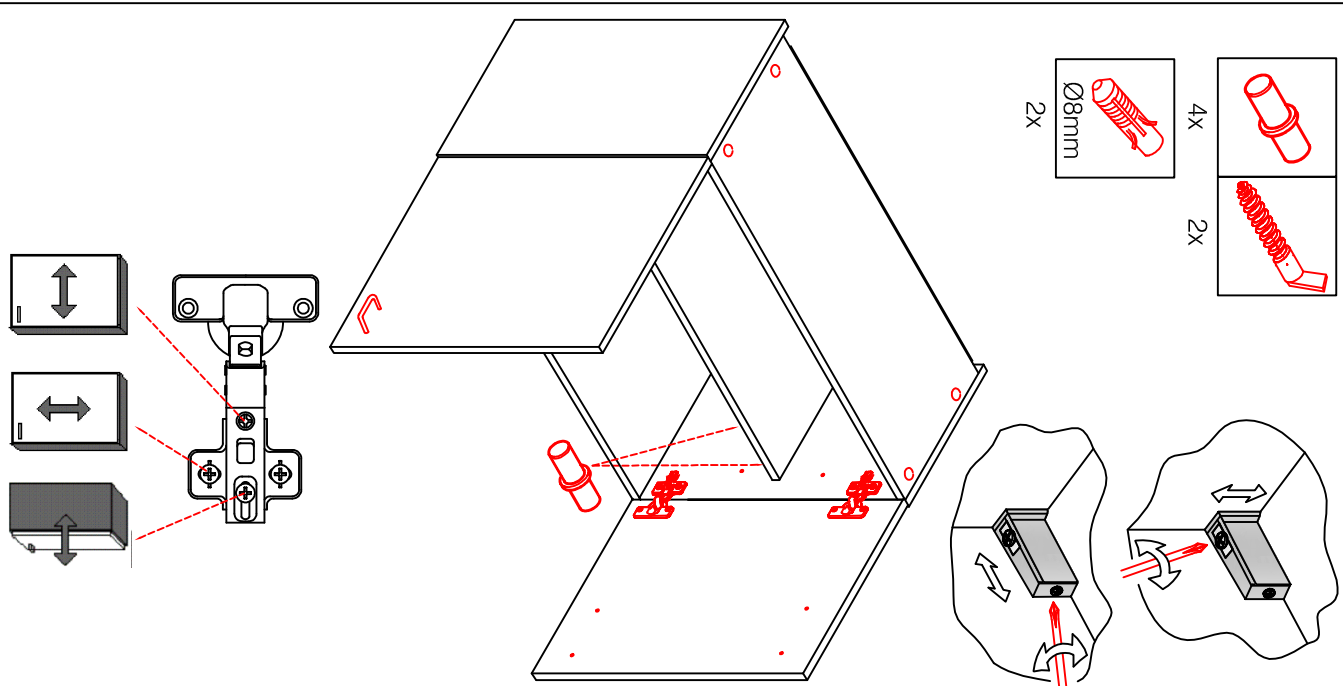

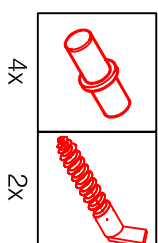
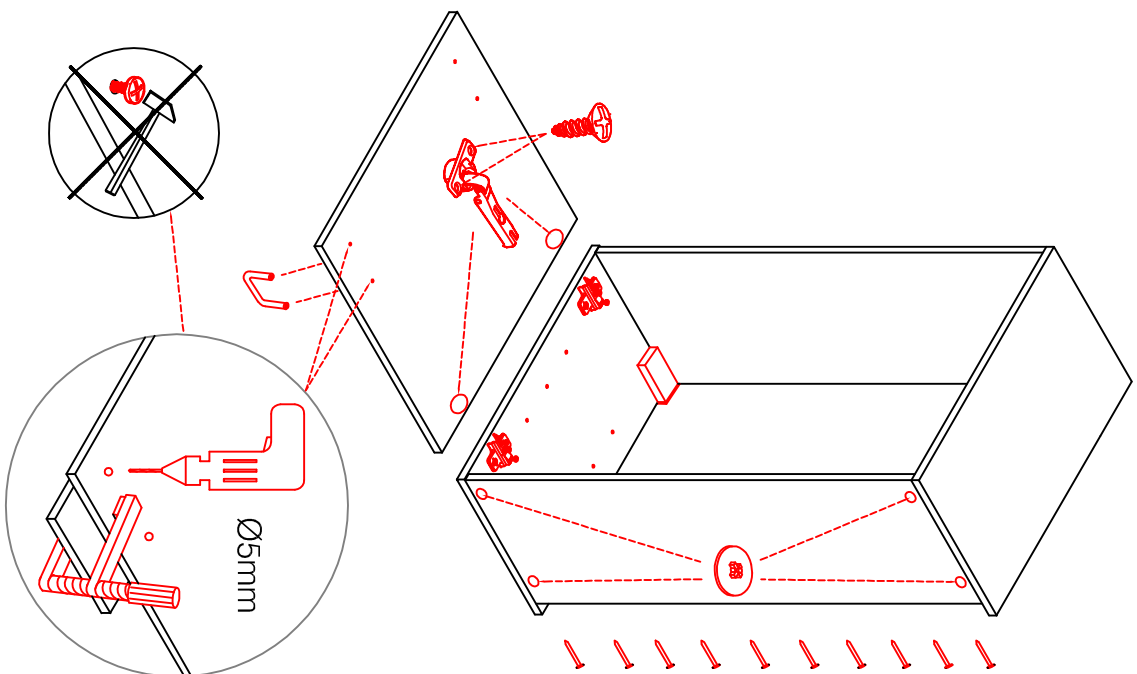
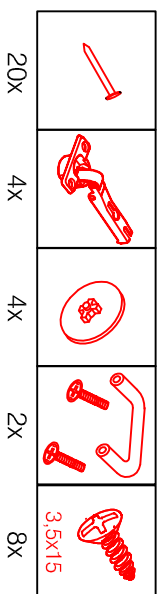
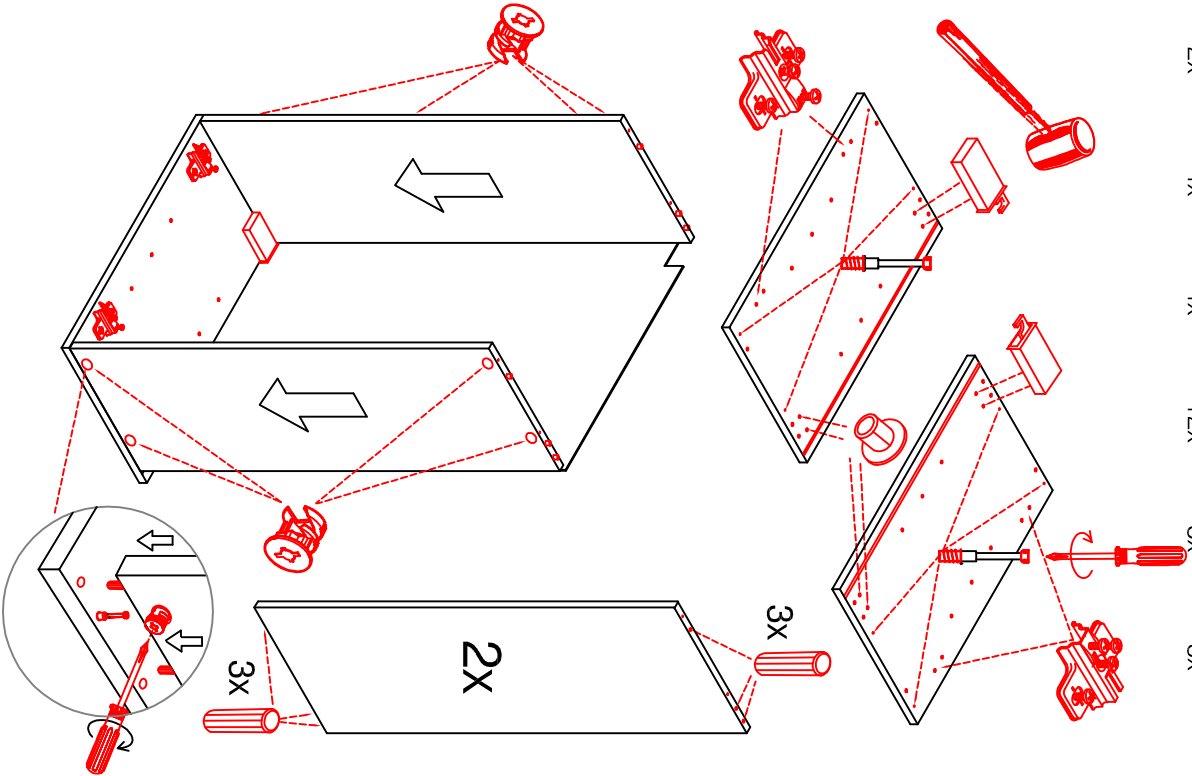
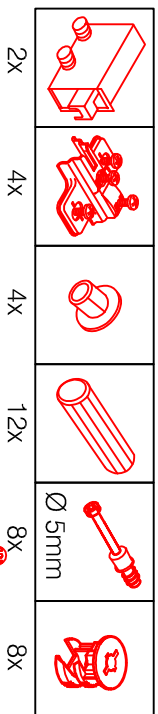

## Varianto

Montageanleitung / Notice de montage / Assembly instruction





# USSA 50 Variante

Montageanleitung / Notice de montage / Assembly instruction



			
4x	16x	2x	4x

Ø5mm





	
6x	2x

3, 5x15





7x

	
4x	14x

3, 5x15

				
2x	4x	6x		

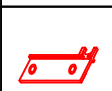
3, 5x30

				
1x	4x	4x	2x	12x

Ø8x10

M4x10

3, 5x15

2x

1

2

A

2x

3, 5x15

2

1

2.5mm



3, 5x15

click

1

2

M4x10

		
6x	4x	1x

3x

Ø5mm

Die Einstellung der Auszug-Blenden bitte durch drehen an den einzelnen Reihlingstangen vornehmen. (heranholen oder wegdücken)

+

-

+

-

# SPU 50 Variante Blocktype

Montageanleitung / Notice de montage / Assembly instruction

